



Allied Bolt Products LLC

## #76187

- Used to secure cable suspension clamps and other poleline brackets and clamps.
- Each square head bolt is supplied with two attached regular square nuts.
- Bolt provided with cone point to ease starting.
- Bolt head marking (ABI) appears on head of each bolt and is registered with the U.S. Patent Office per the Fastener Insignia Act. Tensile load designation mark (i.e. 10M, 16M, 25M) also appears on head of each bolt.
- A minimum of six inches of thread per bolt.
- Hot dig galvanized to meet ASTM Specification F2329.
- Minimum tensile strength: 13,550 lbf.
- Recommended torque value: 73 ft lb.
- Minimum thread length is 6".
- Made in USA.
- Origin: Loves Park, IL

76187	5/8" X 24" A CABLE SUSPENSION BOLT MADE IN USA	20	1	42
-------	---	----	---	----

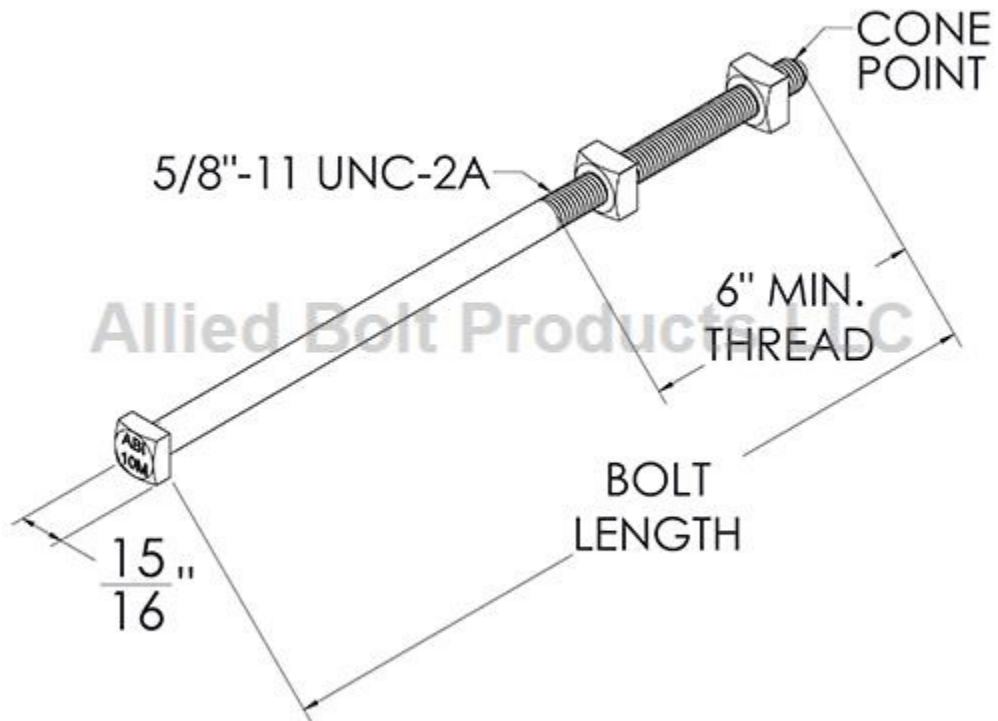

June 17, 2026